

Data Sheet



Article number: 204250M16100A1UK

Description: E+G levelling foot
GN 42-50-M16-100-A1-UK

Note: UK With nut, Hexagon socket at the top, Wrench flat at the bottom

Measures

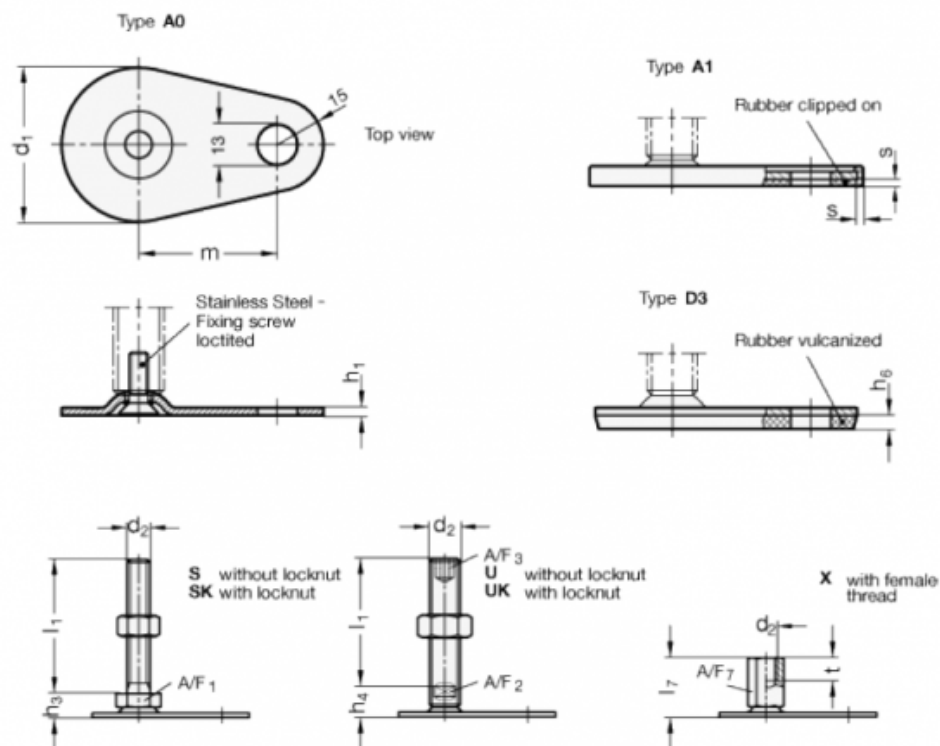

A/F2 = 12	m = 45
A/F3 = 8	s = 2
d1 = 50	
d2 = M16	
h1 = 2.5	
h4 = 17	
h6 =	
l1 = 100	